

SSD
BY Linear[®]

**WIRELESS
SECURITY
SYSTEM**

SSD
BY Linear[®]

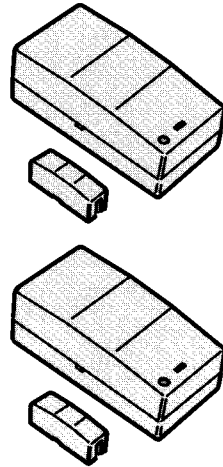
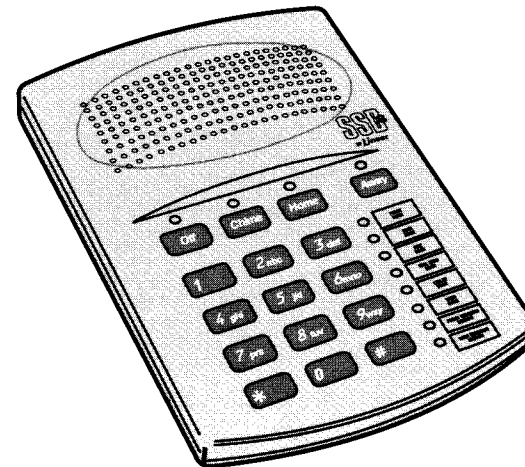

**Installation Instructions
& Owner's Manual**

INTRODUCTION

Congratulations for selecting this Wireless Security System. This Console incorporates many of the advanced and sophisticated features of professionally installed systems, yet it is wireless, and you can easily install it yourself. You can also expand and customize the system to fit your specific needs.

This system is a Residential Security System designed for apartments or homes. Many insurance companies offer discounts on homeowner's and renter's policies when a security system is installed. Discount credits vary with different companies and generally increase in savings with an increase in the level of protection. Ask your insurance agent about available savings for you.

NOTE: Some cities and municipalities may require an alarm system permit. Check with your local authorities before installing this system.

The Console and its accessories are designed and manufactured by the oldest wireless security company in North America. You can look ahead to many years of reliable service and peace of mind with this system on guard for you and your family.

This wireless security system uses battery powered sensors to monitor doors and windows. They each use a small magnet, attached to the door or window, that triggers the sensor when the portal opens or closes. The Console's indicators display the open or closed status of each protected opening. For ease of installation, this system is pre-programmed at the factory. The two door/window sensors supplied have already been programmed as Sensor #1 and #2. A total of eight sensors may be used with the Console.

TABLE OF CONTENTS

SYSTEM COMPONENTS	1	THE OFF MODE	6
COMPATIBLE ACCESSORIES	1	THE CHIME MODE	6
SYSTEM FEATURES	2	THE HOME MODE	7
CONSOLE LOCATION	3	THE AWAY MODE	7
CONNECT ANTENNA	3	INSTALLING SYSTEM BACKUP BATTERIES	8
CONSOLE MOUNTING	3	SYSTEM TESTING	8
APPLY POWER & CREATE YOUR SECRET CODE 3	3	CONNECTING AN EXTERNAL SPEAKER	9
TEST PRE-PROGRAMMED SENSORS	4	CONNECTING A VOICE DIALER	9
SENSOR RESPONSE SWITCH	4	ADDING AND REMOVING SENSORS	10
EXAMPLE SENSOR INSTALLATION	4	TWO-BUTTON REMOTE CONTROL ACCESSORY 11	11
OPTIONAL MAGNET SPACER	5	MOTION DETECTOR ACCESSORY	11
SENSOR INSTALLATION ON DOOR	5	GLASS BREAK SENSOR ACCESSORY	11
SENSOR INSTALLATION ON WINDOW	5	MAGNETIC SWITCH ACCESSORY	12
TEST INSTALLED SENSORS	5	REPLACING SENSOR BATTERIES	12
CONSOLE OPERATION	6	CHANGING YOUR SECRET CODE	12
		RESETTING THE CONSOLE	13
		FCC NOTES	13

SYSTEM COMPONENTS

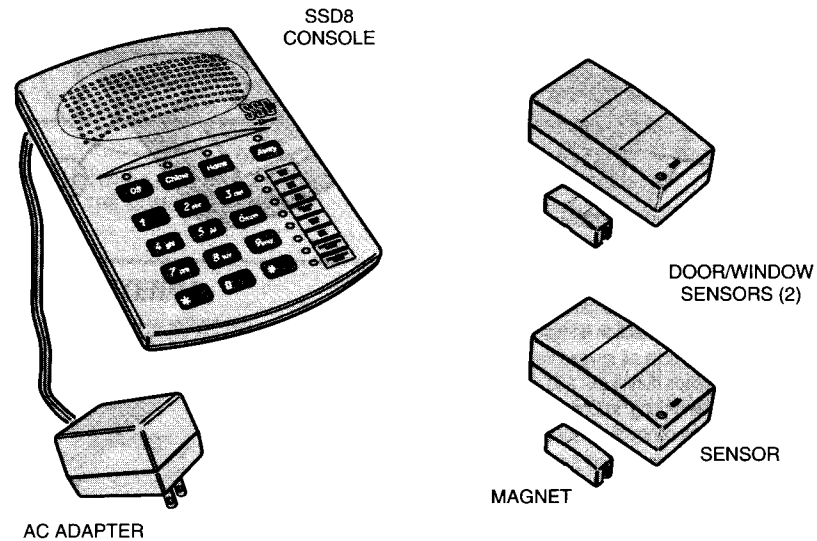

COMPATIBLE ACCESSORIES

EACH OF THESE ACCESSORIES ARE COMPATIBLE WITH THE SSD8 CONSOLE

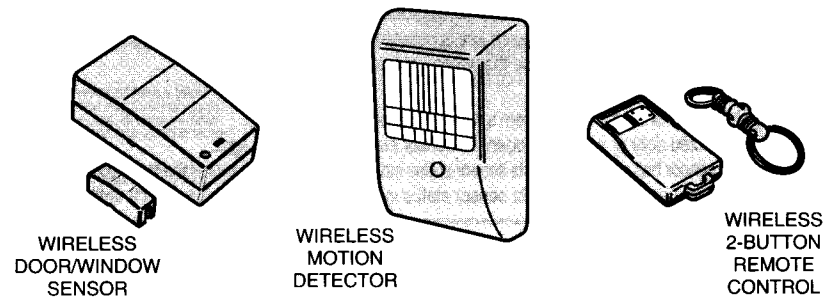

A TOTAL OF EIGHT WIRELESS SENSORS CAN BE USED WITH EACH SYSTEM

NOTE: OTHER SSD ACCESSORIES SOLD ARE NOT COMPATIBLE WITH THE SSD8 CONSOLE

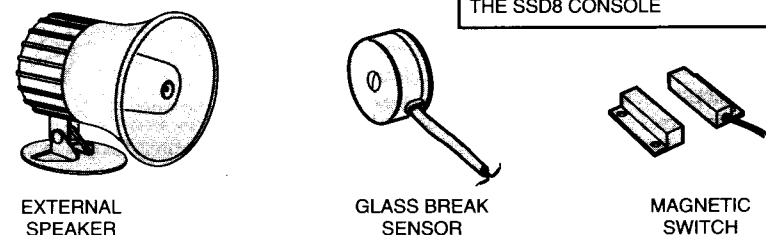

SYSTEM FEATURES

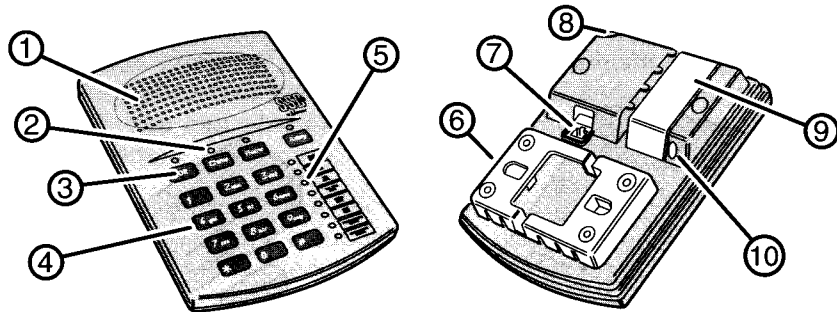

1. SPEAKER

- ★ Sounds unique sirens for burglary or emergency.
- ★ Alarm siren stops automatically after five minutes.
- ★ Sounds mode selection gongs and beeps.
- ★ Sounds keyclicks as keypad keys are pressed.
- ★ Sounds beeps during exit and entry time delays in the Away Mode.
- ★ Sounds "ding-dong" in Chime Mode when protected door or window opens.
- ★ Console has connections for an external speaker.

2. MODE INDICATORS

- ★ Displays which mode the system is currently in.
- ★ During AC power failures, the active mode indicator will blink after 30 seconds.
- ★ The Away Mode indicator will blink during the exit delay time.

3. MODE BUTTONS

- ★ Used to change the operating mode of the Console.
- ★ From the Off Mode, pressing [CHIME], [HOME], or [AWAY] for 2 seconds will arm the system to that mode.
- ★ From Chime Mode, pressing [HOME] or [AWAY] for 2 seconds will arm the system to that mode.
- ★ To disarm the system, your secret code must be entered on the keypad first, then pressing [OFF] or [CHIME] will switch the system to that mode.

4. KEYPAD

- ★ Used to enter your secret code before disarming the system.
- ★ Used during system programming to select sensor location numbers or to change your secret code.
- ★ A beep sounds from the speaker as each key is pressed.
- ★ The [*] key resets the keypad in case the wrong keys are pressed.

5. SENSOR STATUS INDICATORS

- ★ Display the status of each of the system's wireless sensors.
- ★ When a protected door or window is open, its sensor status indicator will light.
- ★ If a wireless sensor has a low battery, its sensor status indicator will briefly flash until the low battery is replaced.
- ★ If an alarm is triggered by a sensor, its sensor status indicator will slowly blink on and off until the system's mode is changed twice.
- ★ Used during programming to show if sensor location is empty or full.
- ★ Area next to the indicators allows labeling each sensor location with the pre-printed labels supplied.

6. WALL MOUNTING BRACKET

- ★ Snaps onto the Console for mounting the unit on the wall.
- ★ Built-in wire holder to store excess AC adapter wire.

7. VOICE DIALER JACK

- ★ For connection to the optional telephone voice dialer.

8. ANTENNA SCREW

- ★ Used to secure the whip antenna in place.

9. BATTERY ACCESS DOOR

- ★ Provides access to the location for the two backup batteries.
- ★ Two 9-volt alkaline batteries are recommended to provide uninterrupted operation during AC power loss.

10. VOLUME CONTROL

- ★ Controls the volume of the system's advisory beeps, gongs, and tones.
- ★ Does not affect the volume of the system's sirens.

CONSOLE LOCATION

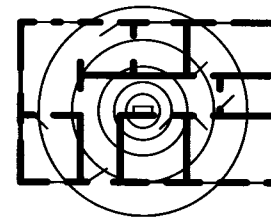

CENTRALLY LOCATE
THE CONSOLE

- The Console must be located where it can easily receive the wireless signals from each of the system's sensors.
- Centrally locate the Console among the system's sensors.
- Keep the Console away from large metal objects.
- You will have 45 seconds to disarm the system when entering. Be sure you can get to the Console from the entry door in 45 seconds.
- Locate the Console near a 115 VAC outlet that is not controlled by a wall switch.

CONNECT ANTENNA

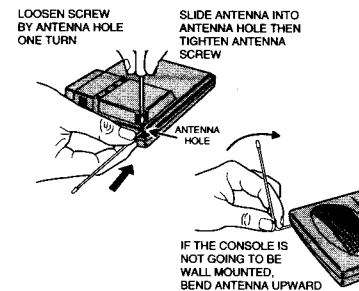

- Loosen screw by antenna hole one turn.
- Insert the whip antenna into the antenna hole on the end of the Console then tighten the antenna screw on the Console bottom.
- If the Console is going to be used on a flat surface, bend the antenna upward (see figure).

CONSOLE MOUNTING

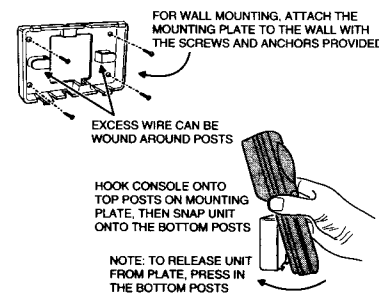

- The Console can be mounted to a wall (recommended) or placed on a flat surface.
- Four small plastic anti-mar "feet" are provided to apply to the unit when used on a flat surface.
- A wall mounting bracket, screws, and anchors are provided to hang the unit on the wall.

APPLY POWER & CREATE YOUR SECRET CODE

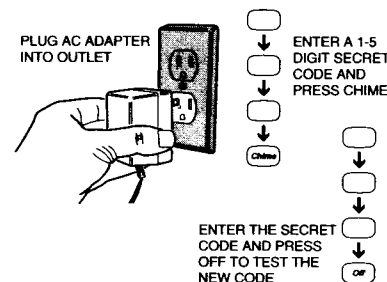

- Plug the AC adapter into the power outlet not controlled by a wall switch. Wait about 5 seconds for the unit's self-test to complete.
- On the keypad, enter a one to five digit secret code, then press [CHIME].
- Verify your secret code by entering it again and pressing [OFF], the unit should switch to the Off Mode (if it doesn't, see Resetting the Console).
- Write down your secret code.
- To change your secret code see the "Changing Your Secret Code" section of this manual.

TEST PRE-PROGRAMMED SENSORS

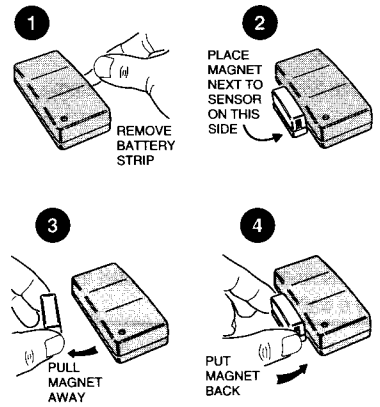

- Place Console in Chime Mode by pressing [CHIME] for two seconds.
- 1. Remove the battery protection strip from each sensor.
- 2. Position the magnets next to the two door/window sensors as shown.
- 3. Move the magnet away from one of the sensors. The Console should "ding-dong" and sensor status indicator #1 or #2 should light.
- 4. Reposition the magnet next to the sensor. The sensor status indicator on the Console should go out.
- Note which sensor location number the sensor is pre-programmed into.
- Perform the same test with the other sensor, noting its sensor number.

SENSOR RESPONSE SWITCH

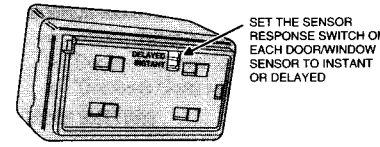

SET THE SENSOR RESPONSE SWITCH ON EACH DOOR/WINDOW SENSOR TO INSTANT OR DELAYED

DELAYED SETTING WILL ALLOW A 45 SECOND DELAY FOR EXIT AND ENTRY IN THE HOME AND AWAY MODES

INSTANT SETTING WILL CAUSE INSTANT ALARMS IN THE HOME AND AWAY MODES

CHIME MODE "DING-DONGS" ARE ALWAYS INSTANT REGARDLESS OF SWITCH SETTING

- Each door/window sensor has an INSTANT/DELAYED switch located on its bottom.
- The switch controls how the Console in the Home or Away Mode will respond to the sensor.
- Sensors set to DELAYED will have a 45 second exit and entry delay. (Use this position for the entry/exit door.)
- Sensors set to INSTANT will trigger the Console immediately. (Use this position for windows and non-entry doors.)

EXAMPLE SENSOR INSTALLATION

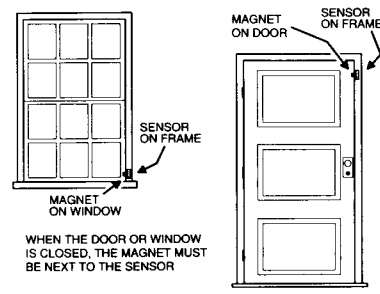

- Sensors mount on the door or window frame.
- Magnets mount on the door or on the moving part of the window.
- Sensors can be mounted with the double-stick tape supplied, or with the screws supplied (screws are recommended in permanent installations).

OPTIONAL MAGNET SPACER

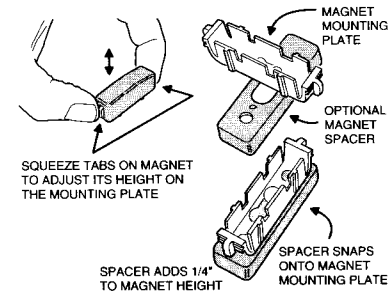

- The magnet's mounting plate is adjustable for small changes in height. Squeeze the magnet ends to adjust the magnet on the mounting plate.
- If the design of the door or window causes the magnet to be much lower than the sensor, a plastic spacer is provided to raise the magnet.
- The magnet spacer snaps onto the magnet's mounting plate.

SENSOR INSTALLATION ON DOOR

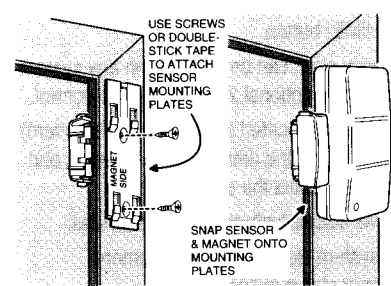

- If this door is the primary entry/exit door, be sure the switch on the bottom of the sensor is in the DELAYED position.
- Note the notch side of the sensor that the magnet aligns to.
- Mount the sensor on the door frame and the magnet on the door. Be sure the magnet is adjacent to the notch on the sensor when the door is closed.
- NOTE: A maximum of 1/2" space is allowable between the magnet and the sensor when the door is closed.

SENSOR INSTALLATION ON WINDOW

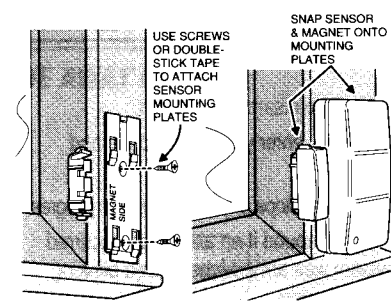

- For windows, set the switch on the bottom of the sensor to the INSTANT position.
- Note the notch side of the sensor that the magnet aligns to.
- Mount the sensor on the window frame and the magnet on the window. Be sure the magnet is adjacent to the notch on the sensor when the window is closed.
- NOTE: A maximum of 1/2" space is allowable between the magnet and the sensor when the window is closed.

TEST INSTALLED SENSORS

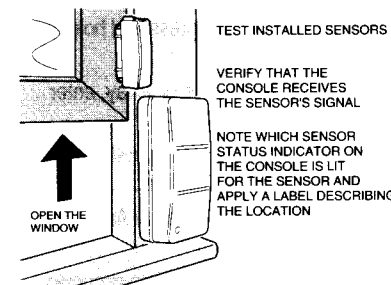

- Test the installed sensors with the Console in the Chime Mode.
- Open one protected opening and verify that the Console sounds a "ding-dong" and that a sensor status indicator lights.
- Apply a sensor label that describes the opening next to the lit status indicator.
- Close the protected opening and verify that its sensor status indicator goes out.
- Repeat the test with any other sensors installed and apply a sensor label describing its location.

CONSOLE OPERATION

SYSTEM MODES

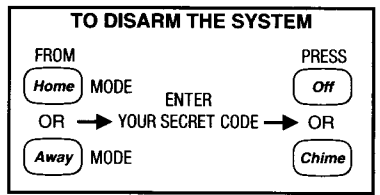
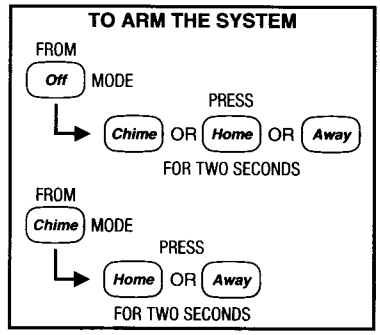
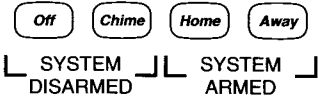

- The Console has four operating modes: Off, Chime, Home, and Away.
- Each mode controls how the system will react to signals from the sensors.
- From the Off Mode, the system can be “quick armed” to the Chime, Home, or Away Modes by pressing the desired mode button for two seconds.
- From the Chime Mode, the system can be “quick armed” to the Home or Away Modes by pressing the desired mode button for two seconds.
- To disarm the system to the Off or Chime Mode, the secret code must be entered *before* pressing the [OFF] or [CHIME] button.
- The emergency siren can be activated in any system mode by using the optional 2-button remote control.
- The volume control (located on the Console’s bottom) adjusts the volume of the advisory tones, beeps, and gongs. It does not affect the siren volume.
- Alarm sirens will automatically stop after five minutes.
- Arming the system clears the alarm memory (blinking sensor status indicators).
- If there is a complete power failure (with no backup batteries installed), when power is restored, the system will restart in the Away Mode.
- The sensor status indicators are active in all system modes.

THE OFF MODE



DOOR/WINDOW SENSORS DISARMED
MOTION DETECTORS DISARMED

- Use the Off Mode to disarm the system.
- To select Off Mode, enter your secret code and press [OFF].
- Disarming the system stops any alarm sirens in progress.
- Multiple beeps will sound if an alarm has occurred when the system was armed (check for a blinking sensor status indicator).

THE CHIME MODE



DOOR/WINDOW SENSORS DING-DONG
MOTION DETECTORS DISARMED

- Use the Chime Mode as an automatic chime.
- To select Chime Mode from Off, press and hold the [CHIME] button for two seconds.
- To select Chime Mode from Home or Away, enter your secret code and press [CHIME].
- Opening any protected door or window will sound a “ding-dong” from the Console’s speaker.
- Switching to Chime Mode from Home or Away Mode will disarm the system.
- Multiple beeps will sound if an alarm has occurred when the system was armed (check for a blinking sensor status indicator).

CAUTION

IF YOU HEAR MULTIPLE BEEPS WHEN DISARMING THE CONSOLE TO OFF OR CHIME MODE, AN ALARM HAS OCCURRED WHILE YOU WERE AWAY. AN INTRUDER MAY STILL BE PRESENT. USE CAUTION.

THE HOME MODE



DOOR/WINDOW SENSORS ARMED
MOTION DETECTORS DISARMED

- Use the Home Mode to arm the system perimeter without arming any interior sensors.
- If any protected doors or windows are open, hi-low beeps will sound when the system is armed. Those openings cannot cause an alarm until they are closed.
- Opening any protected door or window with its sensor’s switch set to INSTANT will cause an instant alarm in this mode.
- Opening any protected door with its sensor’s switch set to DELAYED will cause a 45 second entry delay to begin. Beeps will sound during this delay. **The system must be disarmed within 45 seconds or the burglary siren will activate.**
- If you have installed an interior motion detector, it will *not* cause any alarms in the Home Mode.

SECURE EXIT

- If the system is already in the Home Mode and you want to exit the premises while leaving someone inside, with the system still in Home Mode, press the [HOME] key for two seconds.
- A gong and two beeps will sound and the HOME indicator will blink for 45 seconds.
- You can leave through a door protected with a delayed sensor during the 45 second exit delay without causing the system to begin an entry delay.

THE AWAY MODE



DOOR/WINDOW SENSORS ARMED
MOTION DETECTORS ARMED

- Use the Away Mode to arm the entire system.
- The system will be fully armed 45 seconds after selecting Away Mode (the AWAY indicator will blink and beeps will sound during the exit delay). This delay allows you to arm the system and exit the premises without triggering the alarm.
- If any protected doors or windows are open, hi-low beeps will sound when the system is armed. Those openings cannot cause an alarm until they are closed.
- Opening any protected door or window with its sensor’s switch set to INSTANT will cause an instant alarm in this mode.
- Opening any protected door with its sensor’s switch set to DELAYED will cause a 45 second entry delay to begin. Beeps will sound during this delay. **The system must be disarmed within 45 seconds or the burglary siren will activate.**
- If you have installed an interior motion detector accessory, it *can* cause alarms in the Away Mode.
- If an interior motion detector triggers *before* a delayed sensor, it will cause an instant alarm.

INSTALLING SYSTEM BACKUP BATTERIES

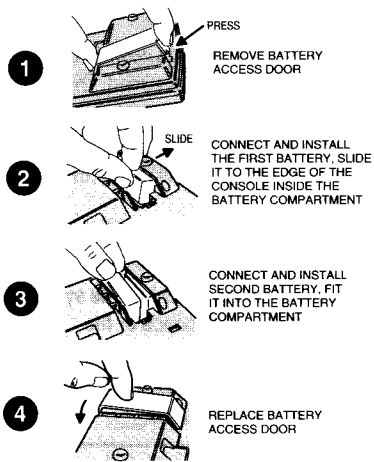

- To provide backup power for the system during AC power failures, installation of the optional Console backup batteries is recommended.
- For backup batteries, use two fresh 9-volt *alkaline* batteries.
 - Remove the battery access door.
 - Snap one of the battery clips onto the first battery and slide the battery into the battery compartment.
 - Snap the other battery clip onto the second battery and fit it into the battery compartment.
 - Replace the battery access door.

SYSTEM TESTING

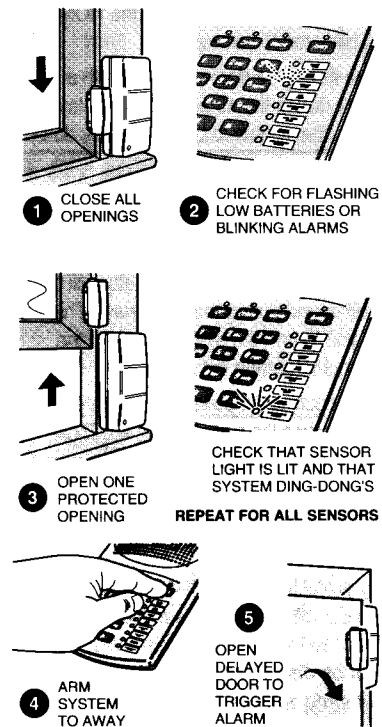

- To verify the system integrity, it is important to test the system on a regular basis.
- Follow these steps to test the system:
 - Start with all protected doors and windows closed and the system in the Chime Mode. Verify that CHIME is the only indicator lit on the Console.
 - If any sensor status indicators are flashing briefly, that sensor has a low battery and its batteries should be replaced (see Replacing Sensor Batteries). If any sensor status indicators are slowly blinking, an alarm has occurred previously from that sensor. Clear the indication(s) by switching the system to Chime Mode again and continue testing.
 - Open a protected opening and verify that the Console "ding-dongs" and that the sensor's status indicator stays lit as long as the door or window is open. Repeat for all other sensors.
 - Arm the system to the Away Mode and wait 45 seconds for the exit delay beeps to stop.
 - Open a *delayed* protected opening. The entry delay beeps should sound for 45 seconds, then the siren should sound. **Disarm the system to Off or Chime Mode to stop the siren.**

NOTE: To test optional motion detectors.

- Stay out of covered area for five minutes.
- Arm system to Away Mode and wait 45 seconds.
- Walk into covered area - alarm should sound immediately.
- Disarm system.

CONNECTING AN EXTERNAL SPEAKER

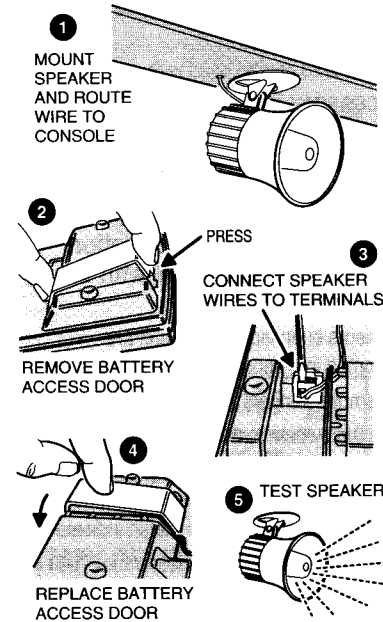

- One optional external speaker can be used with the Console.
- The external speaker will sound the sirens and all of the advisory tones.
- To install an external speaker:
 - Mount the speaker as described in its installation instructions. Route the speaker wiring to the Console.
 - Remove the battery door.
 - Route the speaker wire through the wiring access slot and connect each lead to the speaker connector terminals with a small flat blade screwdriver.
 - Replace the battery door.
 - Arm the system and trigger an alarm, verify that the external speaker sounds the alarm siren and the advisory tones.

CONNECTING A VOICE DIALER

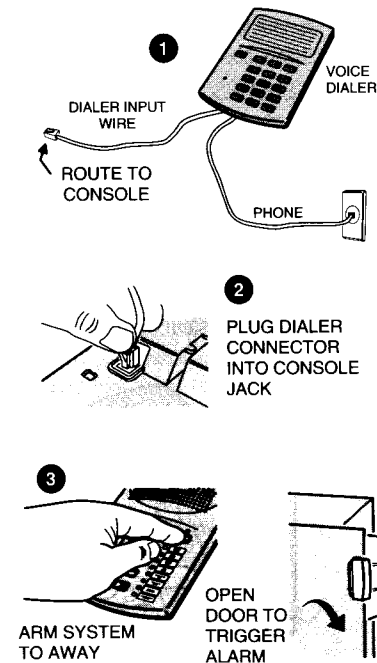

- The Console can be connected to a telephone Voice Dialer.
- A Voice Dialer will call a pre-programmed telephone number if an alarm occurs and play your custom recorded message to the answering party.
- For information on purchasing a telephone Voice Dialer, contact a technical representative at the telephone number listed on the warranty card included with this product.
 - Follow the Voice Dialer installation instructions to connect its telephone wiring. Route the dialer input wire to the Console.
 - Plug the dialer input connector into the dialer jack on the bottom of the Console.
 - After programming the dialer, arm the system and trigger an alarm, verify that the Voice Dialer correctly completes the call and plays the message. After the Voice Dialer completes its telephone call, call the receiving party and verify that the message was correctly sent.

ADDING AND REMOVING SENSORS

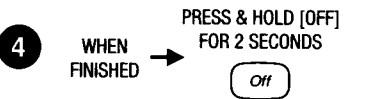
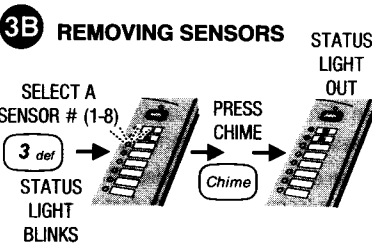
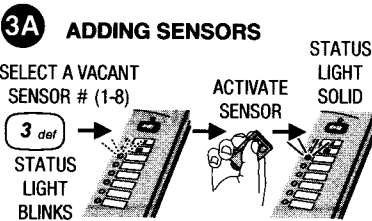
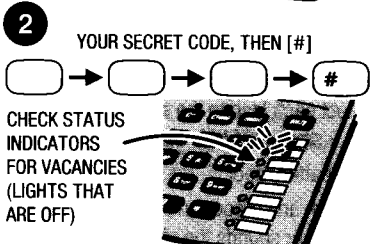

- Additional sensors of various types can be purchased for the Console.
- Up to eight sensors can be used with each Console.
- **Each accessory is supplied with installation and programming instructions. The programming information supplied pertains to the 16-sensor SSD system. Use the following programming information when using the accessories with the 8-sensor SSD8 system.**
- The two sensors supplied with the unit are pre-programmed into sensor locations #1 and #2.
- To add or remove sensors:

1. Start with the system in the Off Mode.
2. Enter your secret code and press [#]. A gong followed by four beeps should sound. All occupied sensor locations will have sensor status indicators lit.

3A. TO ADD SENSORS: Press the number (1-8) of a vacant sensor location. The sensor status indicator for that sensor number will start flashing. Activate the sensor (details in the accessory instructions). A "bing" should sound and the sensor status indicator should light steady, showing that the location is now occupied. **NOTE:** A double-buzz sound means that the location is occupied, choose a vacant location.

3B. TO REMOVE SENSORS: Press the number (1-8) of the sensor to remove. The sensor status indicator for that sensor number will start flashing. Press [CHIME], a "bing" should sound, and the indicator should go out, showing that the location is now vacant.

4. Repeat Step 3A or 3B for additional sensors. When finished, press and hold [OFF] for 2 seconds, a "gong" will sound and the system will return to the Off Mode.

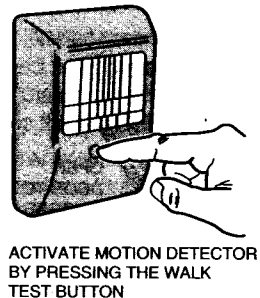
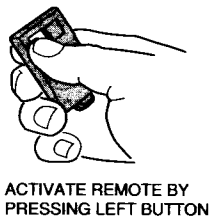

TWO-BUTTON REMOTE CONTROL ACCESSORY

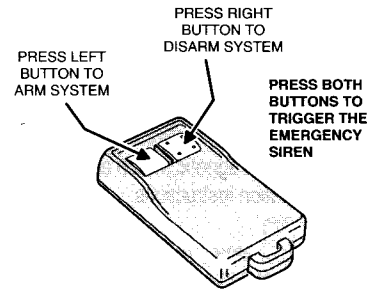

- For remote control of the system, two-button remote controls can be purchased.
- The two-button remote control can be used to arm or disarm the Console and trigger the emergency siren. It is supplied with a snap-action key ring.
- Pressing the left remote control button arms the system to the Away Mode, sounding one chirp.
- Pressing the right remote control button disarms the system to the Off Mode, sounding two chirps.
- Pressing both buttons triggers the system's emergency siren.
- Labels are provided with the remote to identify the buttons.
- Before using the remote, it must be added as a sensor to the system (see Adding & Removing Sensors). **NOTE:** Each remote control requires one sensor location.

MOTION DETECTOR ACCESSORY

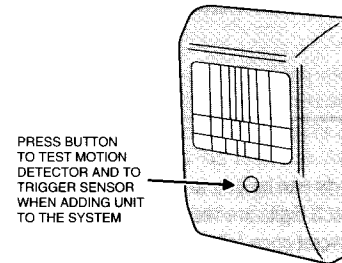

- For interior protection, motion detectors can be purchased.
- The motion detector can trigger the alarm in the Away Mode when motion is sensed in its protection area.
- In the Home Mode, the motion detector is disabled.
- Install and test the detector as described in its installation instructions.
- Before using the motion detector, it must be added as a sensor to the system (see Adding & Removing Sensors).

GLASS BREAK SENSOR ACCESSORY

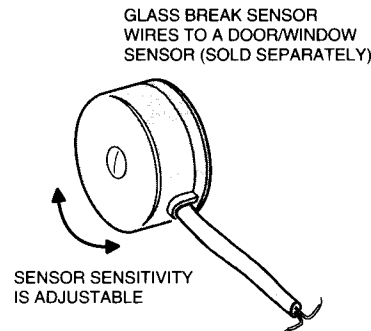

- To detect breaking window glass, a glass break sensor accessory can be purchased to attach to a door/window sensor (sold separately).
- The glass break sensor sticks on the window glass with adhesive and is wired to terminals inside the door/window sensor.
- If the glass breaks, the glass break sensor triggers the door/window sensor, which sends a signal to the Console. The alarm will sound if the system is armed in the Home or Away Mode.
- Install and adjust the glass break sensor as described in its installation instructions.
- Set the door/window sensor switch to instant and program the door/window sensor into the Console (see Adding & Removing Sensors).

MAGNETIC SWITCH ACCESSORY

EXTERNAL MAGNETIC SWITCHES CAN BE USED WITH DOOR/WINDOW SENSORS

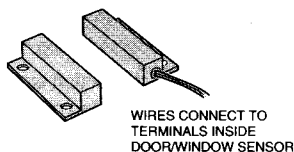

- External magnetic switches can be purchased and wired to door/window sensors for additional protection.
- The external switch can be used with, or instead of, the door/window sensor's internal switch to protect nearby openings.
- Install, wire and test the magnetic switch as described in its installation instructions.

REPLACING SENSOR BATTERIES

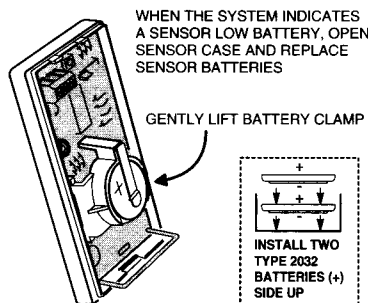

- Each wireless sensor is powered by batteries. When the battery(s) get low, the sensor's status indicator on the Console will briefly flash.
- See the figure for details on replacing the door/window sensor batteries.
- Each accessory sensor's instructions show details for battery replacement.

CHANGING YOUR SECRET CODE

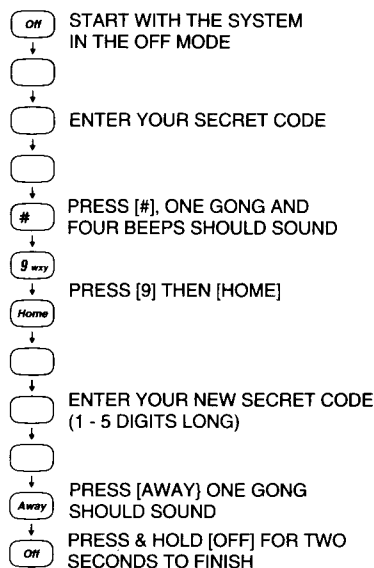

- Your secret code can be one to five digits long (for security at least 3 digits are recommended). To change your secret code follow these steps.
 1. Start with the system in the Off Mode.
 2. Enter your current secret code and press [#]. A gong followed by four beeps should sound.
 3. Press [9] then [HOME].
 4. Enter your new secret code (1 to 5 digits long) and press [AWAY]. One Gong should sound.
 5. Press and hold [OFF] for two seconds to exit programming and return to Off Mode.

RESETTING THE CONSOLE

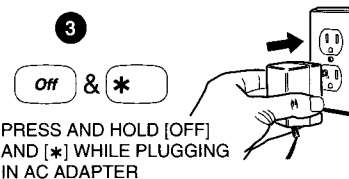

- If you forget your secret code the Console can be reset.
- NOTE: Resetting the Console will erase all of the wireless sensors and the secret code from the system's memory. After resetting, each sensor will need to be added back into the system.
- To reset the Console:
 1. Disconnect the 9-volt backup batteries (if installed).
 2. Unplug the AC adapter.
 3. Press and hold the [OFF] and [*] keys while plugging in the AC adapter. A beep will sound and the system will assume the Off Mode.
 4. Create your secret code (see Apply Power & Create Your Secret Code) and re-program each of the wireless sensors (see Adding and Removing Sensors).

FCC NOTES

- Radio controls provide a reliable communications link and fill an important need in portable wireless signalling. However, there are some limitations which must be observed.
 - ◆ For U.S. installations only: The radios are required to comply with FCC Rules and Regulations as Part 15 devices. As such, they have limited transmitter power and therefore limited range.
 - ◆ A receiver cannot respond to more than one transmitted signal at a time and may be blocked by radio signals that occur on or near their operating frequencies, regardless of code settings.
 - ◆ Changes or modifications to the device may void FCC compliance.
 - ◆ Infrequently used radio links should be tested regularly to protect against undetected interference or fault.
 - ◆ A general knowledge of radio and its vagaries should be gained prior to acting as a wholesale distributor or dealer, and these facts should be communicated to the ultimate users.
- This equipment generates and uses radio frequency energy and if not installed and used properly, that is, in strict accordance with the manufacturer's instructions, may cause interference to radio and television reception. It has been type tested and found to comply with the limits for a Class B digital device in accordance with Part 15 of FCC Rules, which are designed to provide reasonable protection against such interference in a residential installation. However, there is no guarantee that interference will not occur in a particular installation. If this equipment does cause interference to radio or television reception, which can be determined by turning the equipment off and on, the user is encouraged to try to correct the interference by one or more of the following measures:
 - ◆ Relocate the Console away from the TV/radio receiver.
 - ◆ Plug the Console into a different wall outlet so that the Console is on a different branch circuit.
 - ◆ Re-orient the TV/radio antenna.
 - ◆ If necessary, the user should consult the dealer or an experienced radio/television technician for additional suggestions.